

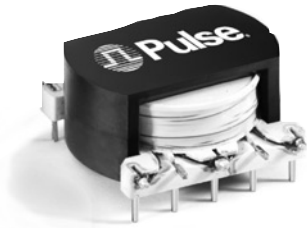



# ISDN U-INTERFACE TRANSFORMERS

## For Lucent ISDN U Transceivers



-  Approved by Lucent for T7234, T7237, T7256, and T7264 transceiver ICs
-  Meets ANSI T1.601-1992 and ETSI ETR 080 standards for longitudinal balance, linearity, and return loss
-  Minimum Isolation: 2000 Vrms
-  Recognized to UL 1459 and UL 1950

### Electrical Specifications @ 25°C — Operating Temperature -40°C to +85°C

Part Number	Turns Ratio Line:Chip (±3%)	Line Side Pins	OCL Line side (mH)	DCR Line Side (Ω)	DCR Chip Side (Ω)	IDC (mA)	Isolation Voltage (Vrms MIN)	Package
T4008	1.50:1	(10-6)	73-98	13 ± 20%	6.5 ± 20%	40	2000	CAP

### Additional Specifications

Return Loss (10 and 25 KHz)	Longitudinal Balance		Surge Voltage Capability		Linearity (500 Hz to 1.5 KHz)
20 dB MIN	281 Hz to 40 KHz	55 dB MIN	Metallic @ 800 V Peak	10/700 μsec	55 dB MIN
—	Above 40 KHz	-20 dB/decade	Long. @ 2400 V Peak	10/560 μsec	—

**NOTE:** Common Mode Chokes for EMI reduction are also available. Recommended part numbers are either **PE-68624** (surface mount) or **PE-65944** (through hole) – see data sheet **G002**. For North American applications when MLT circuit is utilized, DC current through the transformer is minimum. For these applications, smaller size packages are available in both surface mount and through hole configurations. Contact Pulse Applications Engineering at (619) 674-8100 for more information.

### Mechanical

### Schematic

#### CAP

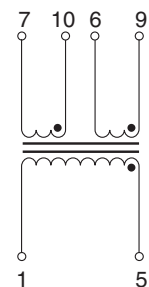
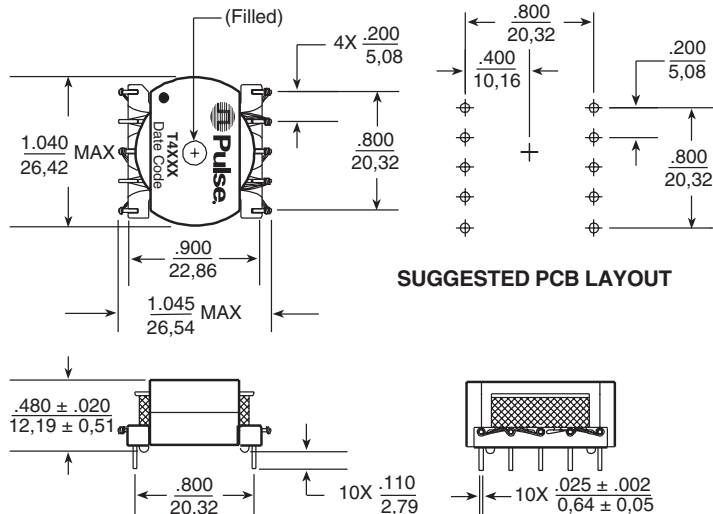

Weight . . . . . 17.7 grams  
Pan Size . . . . . .25/tray

Dimensions:  $\frac{\text{Inches}}{\text{mm}}$   
Unless otherwise specified, all tolerances are  $\pm \frac{.010}{.025}$

### For More Information :

UNITED STATES (Worldwide)	UNITED KINGDOM (Northern Europe)	FRANCE (Southern Europe)	SINGAPORE (Southern Asia)	TAIWAN, R.O.C. (Northern Asia)	HONG KONG (China/Hong Kong)	DISTRIBUTOR
12220 World Trade Drive San Diego, CA 92128 U.S.A. http://www.pulseeng.com TEL: 858 674 8100 FAX: 858 674 8262	1 & 2 Huxley Road The Surrey Research Park Guildford, Surrey GU2 5RE United Kingdom TEL: 44 1483 401700 FAX: 44 1483 401701	Zone Industrielle F-39270 Orgelet France TEL: 33 3 84 35 04 04 FAX: 33 3 84 25 46 41	150 Kampong Ampat #07-01/02 KA Centre Singapore 368324 TEL: 65 6287 8998 FAX: 65 6280 0080	3F-4, No. 81, Sec. 1 HsinTai Wu Road Hsi-Chih, Taipei Hsien Taiwan, R.O.C. Tel: 886 2 2698 0228 FAX: 886 2 2698 0948	9/F, Phase 2, Tai Sang Shatin Warehouse Centre 6 Wong Chuk Yeung Street Fotan, Shatin, Hong Kong TEL: 852 2788 6588 FAX: 852 2776 1055	

Performance warranty of products offered on this data sheet is limited to the parameters specified. Data is subject to change without notice. Other brand and product names mentioned herein may be trademarks or registered trademarks of their respective owners.